

Ensemble

User Manual



 **Avantree®**

Model No.: BTHT-5150P

Table of Contents

Box Contents	5
Product Introduction	6
Product Overview	6
Button Functions.....	7
LED Indicators	8
Setup	9
Connecting the Transmitter to Your TV.....	9
Connecting the Headphones to Transmitter	11
Setting Up Your TV (For optical connections only).....	12
Advanced Features	13
Adding a Second Pair of Headphones.....	13
Using the Headphones with Your Phone/Tablet	14
Charging the Headphones	15
Specifications	16
FAQ	17
Contact Us	95

Box Contents

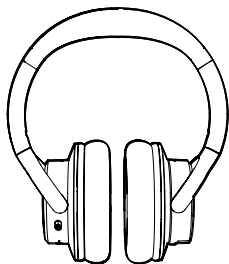

Headphones

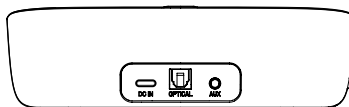

Transmitter / Charging Dock

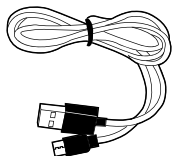

Power Cable fo
Transmitter

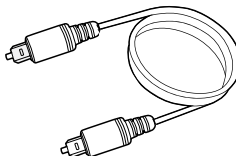

Optical Audio
Cable

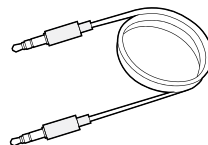

Aux 3.5mm
Audio Cable

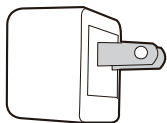

USB Adapter

To view and purchase Ensemble accessories, please visit avantree.com/ensemble/accessories.





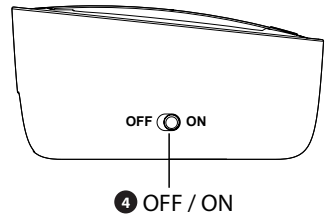
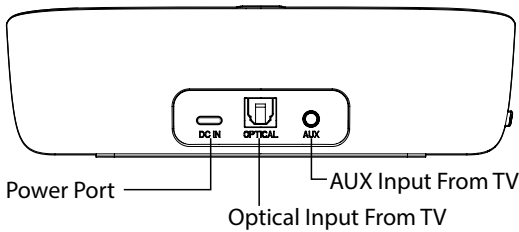
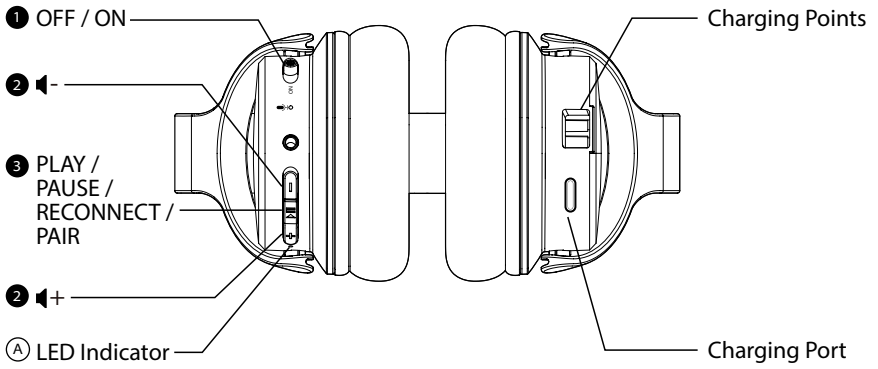

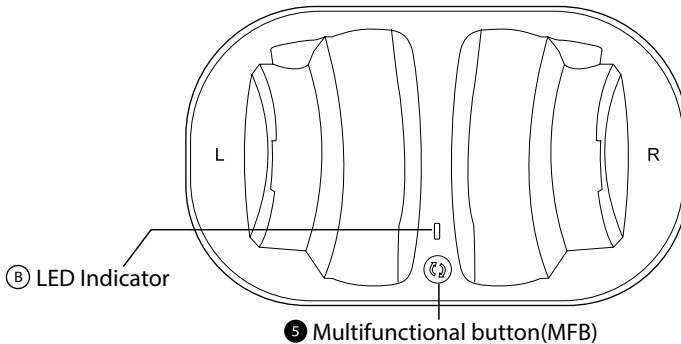
Product Introduction

Product Overview





Button Functions

No.	Button	Function
1	ON  OFF	Switch to turn the headphones on / off
2	+ / -	Press or hold to adjust volume
3		If headphones fail to auto-connect to transmitter, press once to activate reconnection
		Press & hold for 5 seconds to place the headphones into pairing mode
		Press once to play / pause audio (when used separately withphone / tablet)
	Press & hold both buttons  and  to switch between clear voice and balanced sound mode	
4	OFF  ON	Switch to turn the transmitter on / off
5		Press & hold for 5 seconds to place the transmitter into pairing mode

LED Indicators

No.	Indicator	Status
A	Flashing blue	Power on
	Solid blue	Connected
	Flashing red & blue	Pairing mode
	Flashing red	Low battery
	Solid red	Charging
	Off	Charging complete
B	Flashing blue	Power on
	Solid blue	Connected
	Flashing red & blue	Pairing mode
	Solid red	Charging
	Off	Charging complete

Setup

Connecting the Transmitter to Your TV

The transmitter must be connected to a power source in order to function. Connect it to a nearby wall outlet via the provided USB adapter and power cable.

Once the transmitter is connected to its power source, you can connect it to your TV's audio ports. You can choose one of 3 different ways to do this:

OPTION 1 Optical port (recommended)

Plug the provided optical audio cable into the TV's DIGITAL AUDIO OUT (OPTICAL) port, then plug the other end into the transmitter's optical port.

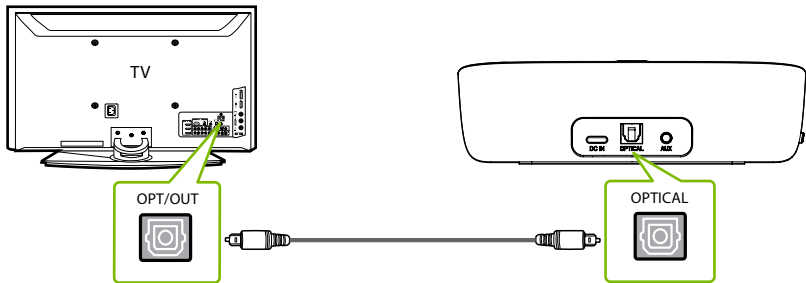

NOTE: Most TVs support audio output through only one digital output port at a time, so if your TV's HDMI ARC port is in use, the optical port may be disabled. You can either unplug the HDMI ARC or try connecting the transmitter via RCA / AUX.

OPTION 2 AUX 3.5mm port

Plug the provided AUX 3.5mm audio cable into the TV's AUX 3.5mm output port, then plug the other end into the transmitter's AUX 3.5mm port.

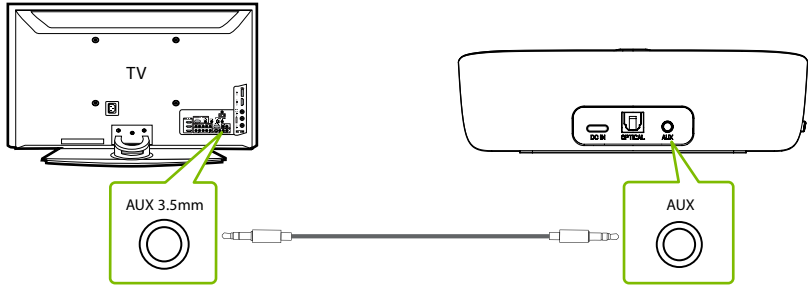
**OPTION 3** RCA port

Connect the RCA adapter(not included) to the AUX 3.5mm audio cable.

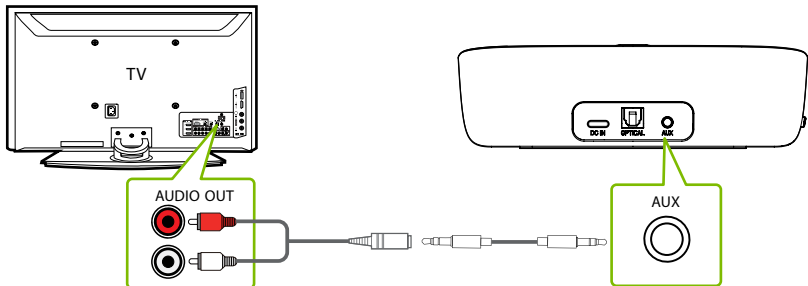

Connecting the Headphones to Transmitter

STEP 1

On your headphones, slide the **OFF**  **ON** switch to the ON position. The LED indicator should start flashing blue.

STEP 2

The transmitter is ON by default. If not, slide its **OFF**  **ON** switch to the ON position. The LED indicator should start flashing blue.

STEP 3

Keep the headphones close to the transmitter; they should connect within 3-5 seconds. Once connected, both the headphones' and the transmitter's LED indicators will turn solid blue.

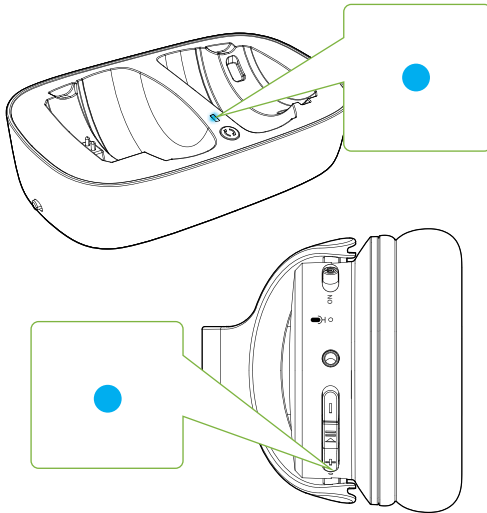

Setting Up Your TV (For optical connections only)

If you connected to your TV via the optical OUT or "OPT OUT" port, you'll need to configure your TV settings before you'll receive audio.

STEP 1

Using your TV's remote control, press the SETTINGS button and navigate to the AUDIO tab within the settings menu. (Please note that there may be differences in the setting names depending on your brand of TV).

STEP 2

Proceed to AUDIO OUTPUT and select "OPTICAL OUT / DIGITAL OUT". Many TVs will do this automatically; skip this step as needed.

STEP 3

Set Audio Output format to "PCM / STEREO" ON or "DOLBY" OFF.

If you're having trouble finding these settings, you can scan the QR code correlating to your TV's brand OR visit avantree.com/ensemble/tv-audio-settings for a more detailed guide.



LG



SONY



SAMSUNG

NOTE1: Some smart TVs automatically reset their settings after system updates. Make sure your audio output / input format is set to "PCM" and NOT "AUTO" or "DOLBY."

NOTE2: When using Netflix or Amazon Prime, you may need to start the movie / show before changing the audio settings to "PCM."

Advanced Features

Adding a Second Pair of Headphones

You can add a second pair of Ensemble headphones (AS50) to your setup while maintaining low latency.

STEP 1

Make sure your original Ensemble headphones & transmitter have connected.

STEP 2

On your transmitter, press & hold the  button until the LED indicator flashes red & blue.

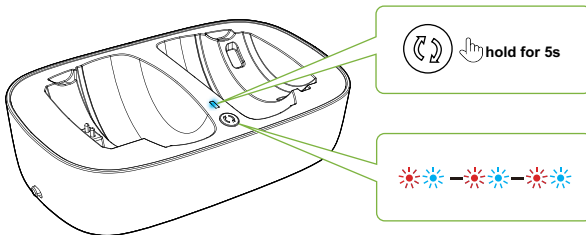

STEP 3

Turn on your second pair of AS50 headphones, then press & hold the  button until the LED indicator flashes red & blue.

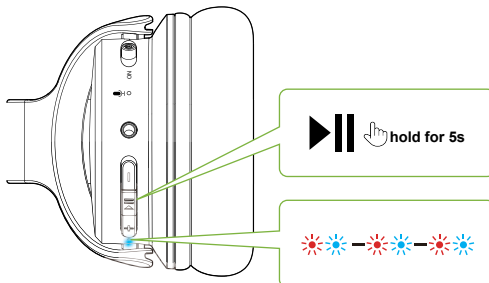

STEP 4

Once connected, the headphones' & transmitter's LED indicators will turn solid blue.

For subsequent use, please turn the original pair of Ensemble headphones on first. Once that's connected to the transmitter, you can turn on your second pair of AS50 headphones and wait for a few seconds. If it fails to reconnect, press the ►|| button once to activate reconnection.

To purchase AS50 headphones, scan the QR code

**Using the Headphones with Your Phone/Tablet****STEP 1**

Turn OFF or unplug the transmitter.

STEP 2

Turn on the headphones and press & hold the ►|| button until the LED indicator flashes red & blue.

STEP 3

Turn on your audio source's Bluetooth and select "Avantree AS50" from the Bluetooth menu.

Charging the Headphones

Place the headphones on the charging dock in order to charge. The charging dock's LED will turn red while charging and off once charging is complete.

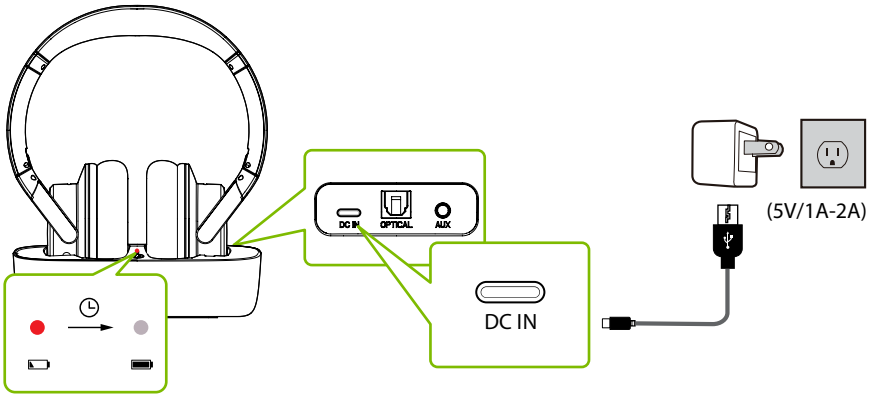

You can also charge the headphones through its power port using a charging cable. A solid red light indicates that charging is in progress; once the light turns off, your headphones will be at full battery. It typically takes 3 hours to fully charge.

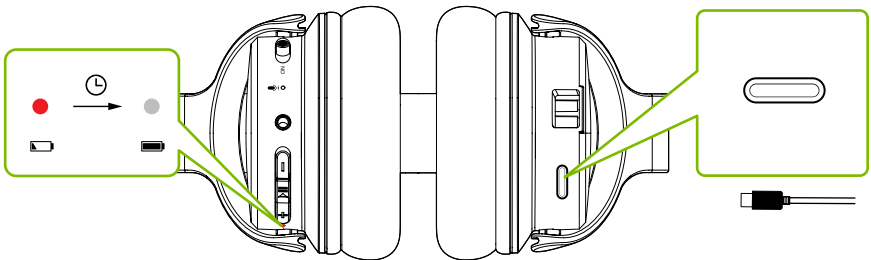

Specifications

Transmitter

Bluetooth version	v5.0
Frequency response	20Hz - 20KHz
Operating range	Up to 100ft / 30m
Bluetooth profiles	HFP v1.7, AVRCP v1.5, A2DP v1.3
Supported audio codecs	aptX-LL, aptX, FastStream, SBC

Headphones

Bluetooth version	v5.0
Frequency response	20Hz-20KHz
Bluetooth profiles	HSP v1.2, HFP v1.6, AVRCP v1.0, A2DP v1.0
Supported audio codecs	FastStream, SBC
Battery life	Up to 35 hours
Impedance	32Ω
Net weight	234g
Earpads inner size	55±1.5 * 43±1.5 * 15±1.5mm

FAQ

Below are some of the most common questions people have during setup.

I have a Samsung / LG TV. Why are my headphones failing to reconnect to the transmitter?

Samsung / LG smart TVs tend to pair with any Bluetooth devices they can find, which blocks the Avantree headphones from reconnecting to its transmitter. Try following the steps below in order to fix this:

DENY the Device - If a popup appears on your TV asking you to Allow or Deny / Block the device to connect to the TV, you **MUST DENY / BLOCK** the device from connecting.

REMOVE the Device - If your device is already paired with the TV, you'll need to remove the device in your TV's settings: **SETTINGS > GENERAL > EXTERNAL DEVICE MANAGER > DEVICE CONNECTION MANAGER > DEVICE LIST > EDIT > Select all Avantree devices > DELETE.**

Please note that the routing may differ based on your TV's brand / model.

Turn OFF the TV - Physically turn your TV OFF or pull the plug (the remote control does NOT turn the TV off; it places it into standby mode which still allows the TV to connect to devices).

Can I have audio through my TV's speakers and wireless headphones at the same time?

This completely depends on whether or not your TV supports the ability to output audio to 2 devices simultaneously. You can try a few different methods to test if your TV is capable of this or not -- please refer to avantree.com/ensemble/sound for more details.

Why aren't I getting sound when watching Netflix / Amazon Prime?

Why aren't my headphones connecting to the transmitter?

.....

For answers to questions like these and for a full FAQ list, you can visit avantree.com/support/ensemble, or you can contact us directly for additional assistance.

Contact Us



Support Tickets avantree.com/submit-a-ticket



Support Email support@avantree.com



Support Numbers

US	+1 800 232 2078	9am-6pm PST	Mon-Fri
CA	+1 800 232 2078	9am-6pm PST	Mon-Fri
UK	+44 208 068 2023	9am-6pm GMT	Mon-Sat
DE	+49 322 2109 7297	11am-9pm CET	Mon-Sat
FR	+33 17 634 0312	11am-9pm CET	Mon-Sat
IT	+39 069 4803 330	9am-6pm CET	Mon-Sat
ES	+34 93 1786 261	9am-6pm CET	Mon-Sat
AU	+61 2 8310 9897	11am-7pm AEST	Mon-Fri



FAQ avantree.com/support/ensemble



Video Guide avantree.com/ensemble/video



Product Registration See QR code on the product.

Manufacturer:
Avantronics Limited
Luohu District, Shenzhen 518000 China
+ 86 755 8228 5022 support@avantree.com

US Importer:
Avantree Corporation
San Jose, California 95119 USA
+1 800 232 2078 support@avantree.com

UK Importer:
Avantree Limited
Watford, WD180 0HQ UK
+44 20 8068 2023 support@avantree.com



Service in Europe:
Gizmex GmbH,
Sternstr. 67, 40479 Dusseldorf, Germany
+49 322 2109 7297 support@avantree.com



Model No.: BTHT-5150
Dispose of the packaging and this product in accordance with the latest provisions.
Z-PKOG-HTS150P-V0